

Led sensors

SWITCH-INBOUW

These VOLTRON® LED high-quality built-in sensors are used for cupboard doors and drawers. Detection takes place based on turn on the bidirectional IR beams that are interrupted. It is best to place the sensor as close as possible to the stop of the cupboard door or drawer. SWITCH-INBOUW : connectable load = max. 96W (advice <85W) - IP20 - Ø = 15mm (hole = 11mm) - color = white - operation up to >180.000 connections - cable lengths: 2m (sensor/controller) + 25cm (controller/power supply and controller/LED). Always 5 years warranty. In combination with VOLTRON® LED strips or LED panels

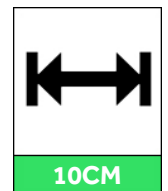
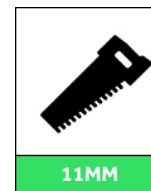
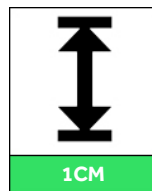
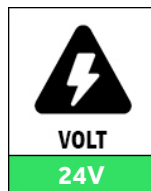
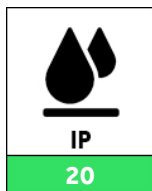
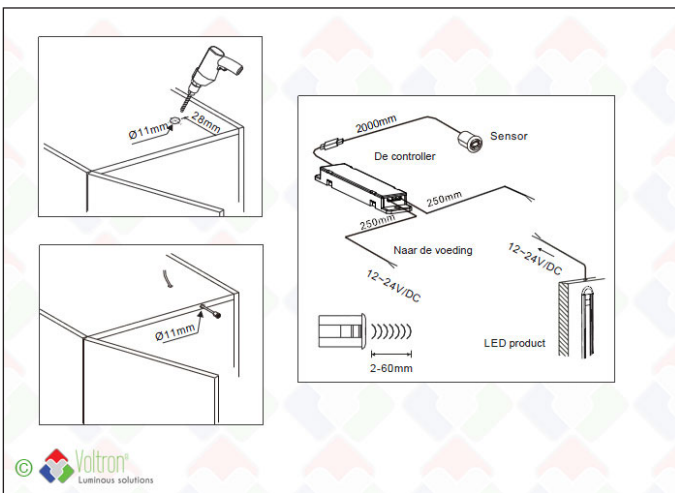
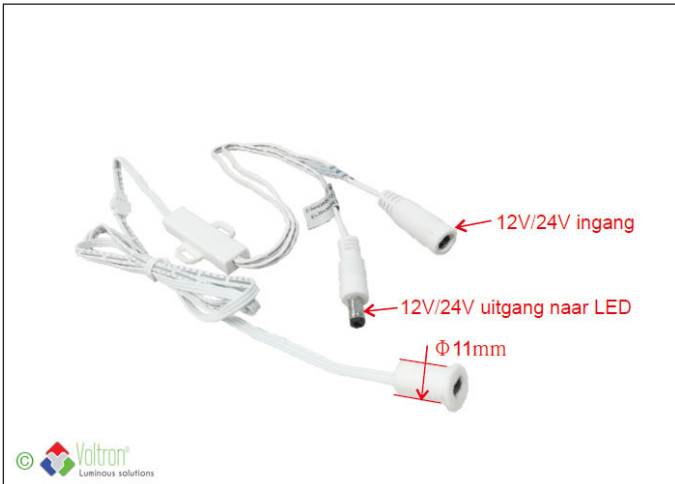

Technical data

Productnumber	Barcode	IP value	Voltage	Wattage
SWITCH-INBOUW	LH-927	20	24V	24V:<96W
Length	Width	Height	Diameter	Punch hole
10CM	1CM	1CM	15MM	11MM
Finishing color	Cable length	Constant voltage	Packed by	Full package
White	200CM	V	1	50

Specification text*

LED built-in sensor for installation in cupboard doors and drawers. Detection by means of bidirectional IR beams. Maximum connected load 24V = 96W. White finish color. 2M cord between sensor and controller. Outer diameter of detection eye = 15mm. Clock hole = 11mm. Service life of switches > 180,000. 5 years warranty.

* Available on the website

Areas of application

Cable length between sensor and controller is: 2 meters / Cable length between the controller and a power supply connection: 25 cm / Cable length between the controller and the LED connection: 25 cm / Min number of circuits that these sensors can handle = +180,000 / The SWITCH CONSTRUCTION and SWITCH -INBOUW is the perfect solution for all possible applications for cabinets, drawers, etc ... by using 1 switch per opening door, this can be perfectly combined with LED strips, aluminum bars 50 cm or the LED panels. / The SWITCH-PIR is the ideal solution for a dressing, the customer comes in and the eye detects the presence and the light comes on. After the eye can no longer detect a detection for 40 seconds, the light will automatically go out. / A point of attention, the controllers may be loaded with MAX 96W, it is recommended to use the 100Watt MeanWell power supply. / It is advisable to remain under 90 Watts to keep the controller under load.

Extra information

All information, specification texts, photos, technical drawings, connection diagrams, photometric .LDT files can be found via this clickable direct link: https://www.voltron-lighting.com/product/EN/44/927/Led_sensors--SWITCH-INBOUW or can be requested through your contact person.

Direct link website



Product barcode



The Voltron® name and logo as well as product names are part of the Voltron® Lighting Group and are protected by national and international laws.

The usage rights, reproduction rights as well as the intellectual rights are the exclusive property of the Voltron® Lighting Group.

Voltron® pays a lot of attention to the correctness and completeness of the information. However, it cannot be held responsible for any inaccuracy and / or omission. All images and texts are protected under copyright law and may not be used or multiplied without express permission.